

Switching Power Supply Type SPP1 60W Enclosed type

CARLO GAVAZZI



- Universal AC input full range
- Short circuit protection
- Internal input filter
- High efficiency
- High average efficiency (meets ErP)
- Low stand-by power consumption
- CE, TUV, and cURus approved

Product Description

Enclosed Switching Power Supply meets your needs for AC DC and DC DC power requirements. SPP provides the most flexible OEM system power solutions from 5V to 24V at 20W for industrial control and automation applications. All the range carries full certification and offers a wide range of universal input and screw terminal connections. It has been designed for its performance and compact dimensions.

Ordering Key

SP P1 24 60 1 X

Model _____
 Mounting (P1 = Panel) _____
 Output voltage _____
 Output power _____
 Input Type _____
 Optional features _____

Input type: 1= single phase

Approvals



Output Performance

MODEL NO.	INPUT VOLTAGE	OUTPUT POWER	OUTPUT VOLTAGE	OUTPUT CURRENT	EFF. (min.)	EFF. (typ.)	EFF. (avg.)
Single Output Models							
SPP1 05601	88~264 VAC	45 WATTS	+ 5 VDC	9000 mA	80%	82%	81%
SPP1 12601	88~264 VAC	60 WATTS	+12 VDC	5000 mA	86%	88%	87%
SPP1 15601	88~264 VAC	60 WATTS	+15 VDC	4000 mA	87%	89%	87%
SPP1 24601	88~264 VAC	60 WATTS	+24 VDC	2500 mA	87%	89%	87%

Output Data All specifications are at nominal values, full load, 25°C unless otherwise stated

Line regulation	± 0.5%	Temperature coefficient	± 0.03%/°C
Load regulation	±1%	Hold up time $V_i = 115VAC$	10ms
Minimum load	0%	$V_i = 230VAC$	80ms
Turn on time (full resistive load)		Voltage fall time (I_{0nom})	150ms max
5V, 12V & 15V Model	1500 ms	Voltage trim range	
24V Model	2000 ms	5V Model	4.75 - 5.5 VDC
5V, 12V, & 15V Model	2000 ms with 7000µF CAP	12V Model	10.8 - 13.2 VDC
24V Model	2500 ms	15V Model	13.5 - 16.5 VDC
Transient recovery time	2ms	24V Model	24.6 - 27.6 VDC
Ripple and noise	100mVpp		
Output voltage accuracy	+ 1%		

Switching Power Supply
Type SPD 60W
DIN rail mounting

Rated continuous loading

5V Model	9A @ 5VDC/8.1A @ 5.5VDC
12V Model	5A @ 12VDC/4.5A @ 13.2 VDC
15V Model	4A @ 15VDC/3.6A @ 16.5VDC
24V Model	2.5A @ 24VDC/2.15A @ 27.6VDC



Output Data All specifications are at nominal values, full load, 25°C unless otherwise stated

Rated continuous loading		Capacitor load	7000µF
5V Model	9A @ 5VDC/8.1A @ 5.5VDC	Voltage rise time	
12V Model	5A @ 12VDC/4.5A @ 13.2 VDC	Vi nom, Io nom (full resistive load)	150ms
15V Model	4A @ 15VDC/3.6A @ 16.5VDC	5V, 12V, & 15V Models:	500ms with 7000µF CAP load
24V Model	2.5A @ 24VDC/2.15A @ 27.6VDC	24V Model:	500ms with 3500µF CAP load
Reverse voltage			
5V Model	7.5VDC		
12V Model	18VDC		
15V Model	22VDC		
24V Model	35VDC		

Input Data All specifications are at nominal values, full load, 25°C unless otherwise stated

Rated input voltage I _{nom}	100 - 240VAC	Power dissipation	
Voltage range		(Vi : 230VAC, Io nom)	
AC IN	88 - 264VAC	5V Model	11W
DC IN	120 - 375VDC	12V Model	10W
Rated input current		15V Model	9W
Vi 115/230 VAC I _{onm}	1100/600mA	24V Model	8W
Vi: 88 VAC, I _{onm}	1500mA	Frequency range	47- 63Hz
Inrush current		Leakage current	
Vi= 115VAC	30A	Input-Output	0.25mA
Vi= 230VAC	60A	Input-FG	3.5mA

Controls and Protection All specifications are at nominal values, full load, 25°C unless otherwise stated

Overload	110 – 150%	Over voltage protection	VDC	
Input fuse	T2A/250VAC internal ¹⁾		Min.	Max.
Output short circuit	Hiccup mode	5V Model	5.75	6.75
		12V Model	13.8	16.2
		15V Model	17.25	20.25
		24V Model	28.8	32.4

¹⁾ Fuse not replaceable by user

General Data All specifications are at nominal values, full load, 25°C unless otherwise stated

Ambient temperature	-40°C to +71°C	MTBF (Bellcore issue 6 @ 40°C, GB)	
Derating (+56°C to +71°C)	2.5%/°C (see curve)	5V Model	570000 Hours
Relative humidity	20 ~ 95%RH	12V Model	588000 Hours
Storage	-40°C to +85°C	15V Model	602000 Hours
Protection degree	IP20	24V Model	615000 Hours
Cooling	Free air convection	Case material	Metal
Insulation voltage		Altitude IEC 60068-2-13	4850m
Input-Output	3.000VAC/4242VDC min	Stand-by power consumption	0.3 W
Input-FG	1.500VAC/2121VDC min	Dimensions LxWxD mm(inch)	98(3.86)x82(3.23)x35(1.38)
Insulation resistance I/O	100MΩ min (@ 500VDC)	Weight	310g
Switching Frequency	65 Khz		

Norms and Standards

Vibration resistance	meet IEC 60068-2-6 (10-500Hz, 2G, along X, Y, Z each Axis, 60 min for each Axis)
Shock resistance	meet IEC 60068-2-27 (15G, 11ms, 3 Axis, 6 faces, 3 times for each face)
UL / cUL	UL60950-1, Recognized
TUV	EN 60950- 1CB scheme

CE	EN 61000-6-3, EN 55022 Class B, EN 61000-3-2, EN 61000-3-3, EN 61000-6-2, EN 55024, EN 61000-4-2, EN 61000-4-3, EN 61000-4-4, EN 61000-4-5, EN 61000-4-6, EN 61000-4-8, EN 61000-4-11, ENV 50204, EN 61204-3
-----------	--

Block Diagrams

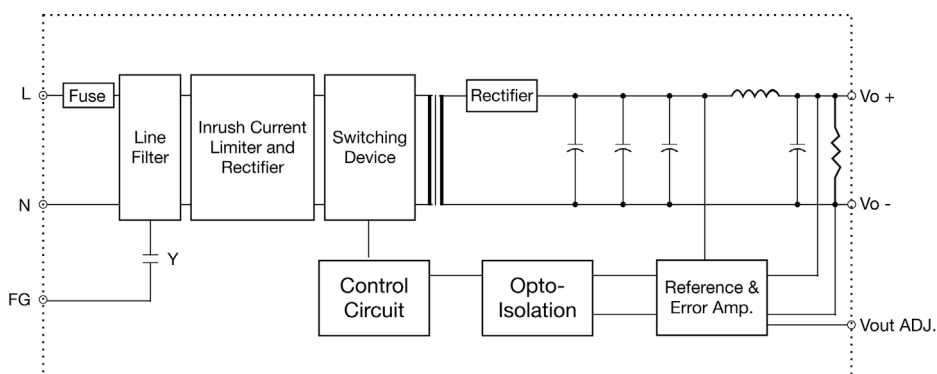

Pin Assignment and Front Controls

Pin No.	Designation	Description
1	L	Input terminals (phase conductor, no polarity at DC input)
2	N	Input terminals (neutral conductor, no polarity at DC input)
3	⊕	Ground this terminal to minimize high-frequency emissions
4	-	Negative output terminal
5	+	Positive output terminal
	Vout ADJ	Trimmer-potentiometer for Vout adjustment
	DC ON	Operation indicator LED

Typ. Efficiency Curve

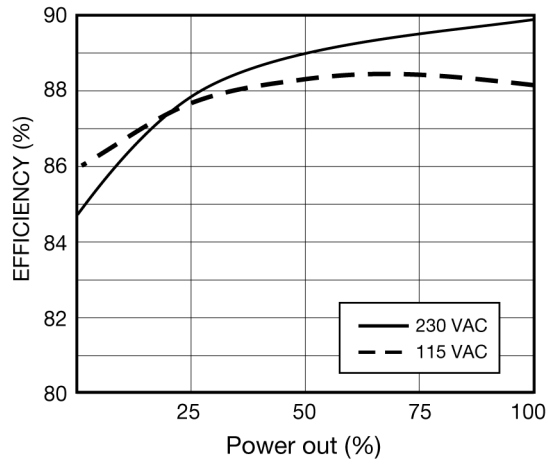

Derating Diagram

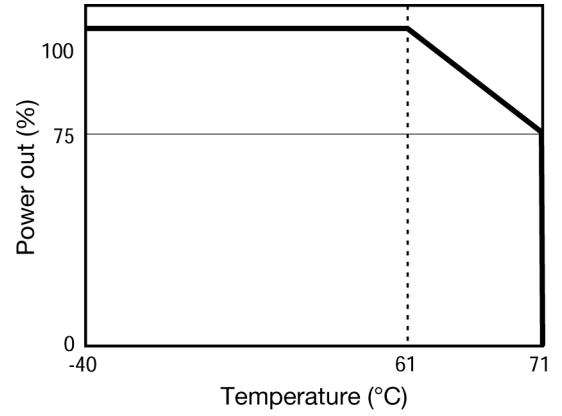

Typ. Current Limited Curve

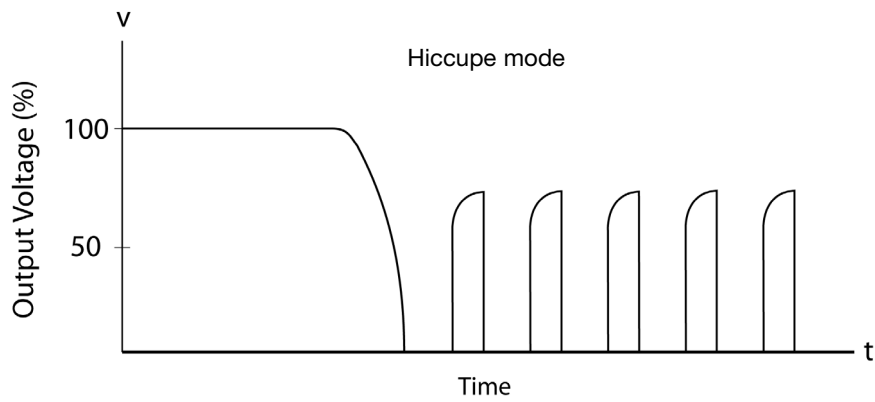

Mechanical Drawings mm (inches)

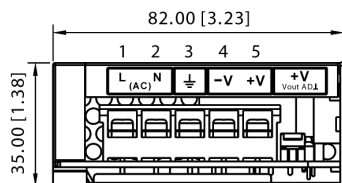
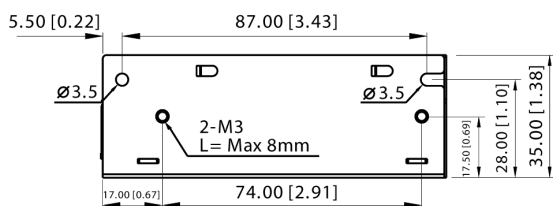
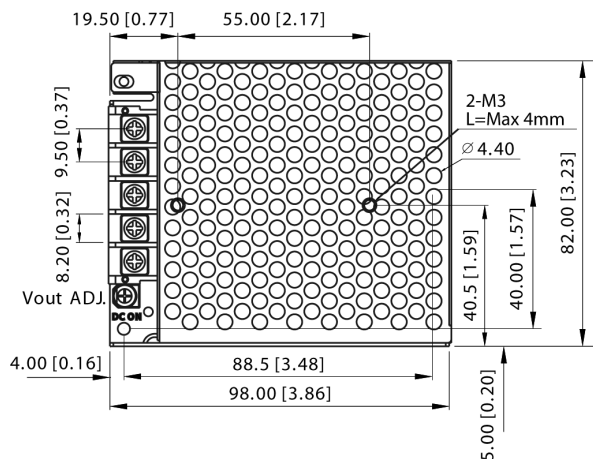

Installation

Ventilation and cooling	Ventilation/Cooling Normal convection
Connector size range Spring terminal	AWG22-12 (0.2~2.5mm ²) flexible/solid cable, connector can withstand torque at maximum 0.90 Nm (8 lb/in)
Max. torque for terminal Input terminals Output terminals	0.56Nm (5.0lb-in) 0.56Nm (5.0lb-in)
General tolerances mm(in.) 0.00 (0.00) ÷ 30.00 (1.18) 30.00 (1.18) ÷ 120.00 (4.72)	±0.30 (0.01) ±0.50 (0.02)