

Photoelectrics

Retro-reflective, Polarized, Relay Output

Type PC50CNP06RP

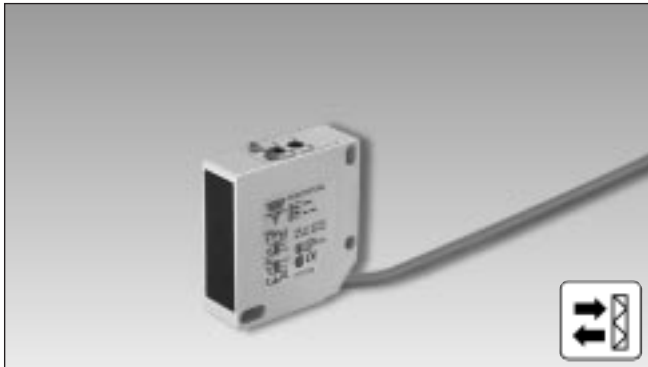

- Range: 6 m
- Adjustable sensitivity
- Modulated, visible red light, polarized
- High immunity to shiny surfaces
- Supply voltage:
12 to 240 VDC and 24 to 240 VAC, 50/60 Hz
- Output: Relay 3 A, 30 VDC, 230 VAC
- Make or break switching function
- LED-indication for output ON, signal stability and supply ON
- High EMC immunity

Preliminary data sheet

Product Description

The PC50CNP. is a general purpose polarized retro-reflective sensor in a compact squared 17 x 50 x 50 mm reinforced PC/ABS-housing. It is useful in applications where basic sensors provide ade-

quate sensing performance. The long sensing range in addition to sensitivity adjustment gives a very flexible sensor. Light and dark operation is switch selectable.

Ordering Key

PC50CNP06RP

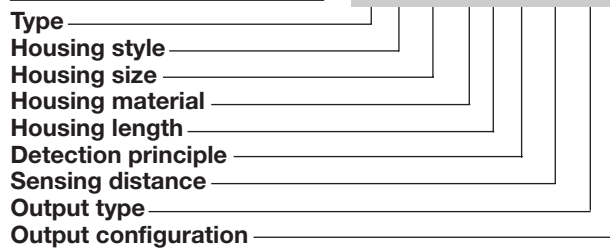

Type Selection

Housing W x H x D	Range (S _r)	Ordering no. Make and break switching
17 x 50 x 50 mm	6 m	PC 50 CNP 06 RP

Note: Reflectors to be ordered separately

Specifications

Rated operating distance (S_r)	Up to 6 m, with reflector type ER 4, Ø84, ref. target	Operating frequency	20 Hz
Blind zone	Max. 15 cm	Response time OFF-ON (t _{ON}) ON-OFF (t _{OFF})	≤ 25 ms ≤ 25 ms
Sensitivity	Adj. by single-turn. pot.	Power ON delay (t_v)	≤ 300 ms
Temperature drift	± 0.5%/°C	Output function	Light or dark operation is switch selectable
Hysteresis (H) Differential travel	3-20%	Indication function Output ON Supply ON, signal stability	LED, yellow LED, green
Rated operational volt. (U_B)	12-240 VDC 24-240 VAC, 50 to 60 Hz	Environment Overvoltage category Pollution degree	II (IEC 60664/60664A; 60947-1) 3 (IEC 60664/60664A; 60947-1) Degree of protection IP 65 (IEC 60529; 60947-1)
Rated operational power	≤ 2.5 VA (relay ON)	Temperature Operating Storage	-20° to +60°C (-4° to +140°F) -25° to +70°C (-13° to +158°F)
Output Contact ratings Resistive loads AC 1 DC 1	3 A/230 VAC 3 A/30 VDC (>10 mA/5 VDC)	Vibration	10 to 150 Hz, 0.5 mm/7.5 g (IEC 60068-2-6)
Mechanical life (typical)	≥ 15 x 10 ⁶ operations	Shock	2 x 1 m & 100 x 0.5 m (IEC 60068-2-32)
Electrical life (typical)	≥ 1 x 10 ⁵ operations at 3 A/230 VAC	Rated insulation voltage	230 VAC (rms)
Protection	Reverse polarity, transients		
Light source	GaAlAs, LED, 660 nm		
Light type	Visible red, modulated		
Sensing angle	± 2°		
Ambient light	Max. 10'000 lux		



Specifications (cont.)

Housing material	PC/ABS, grey reinforced Front glass Red PMMA Mounting bracket	Weight	130 g
Connection	Cable Cable gland	CE-marking	Yes
	Grey, 2 m, 5 x 0.25 mm ² Nickel-plated brass		

Operation Diagram

tv = Power ON delay

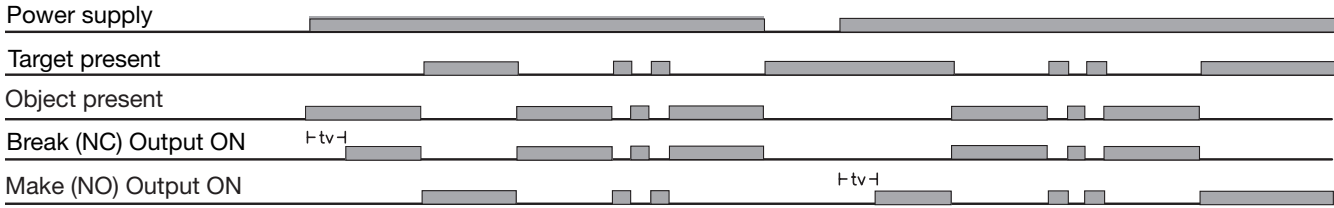

Dimensions

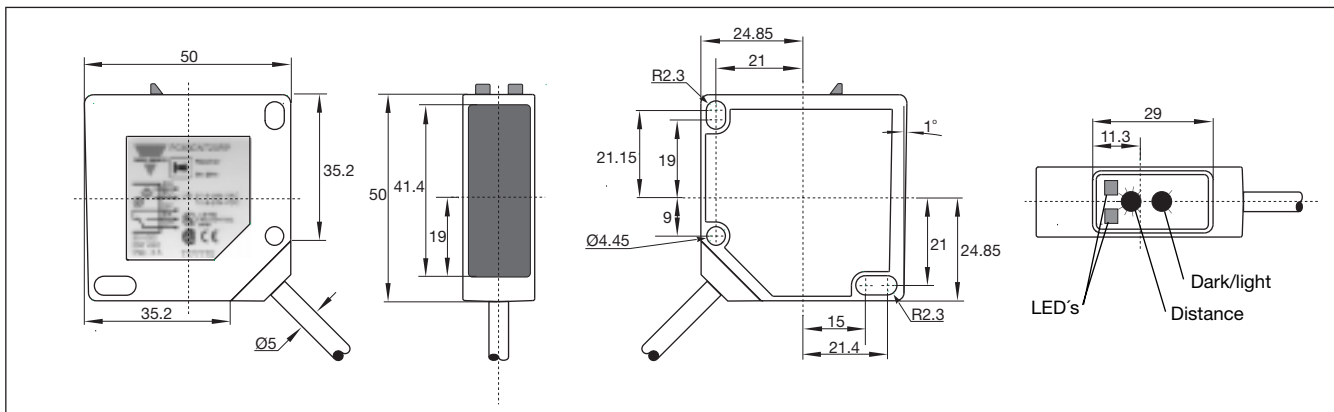

Wiring Diagram

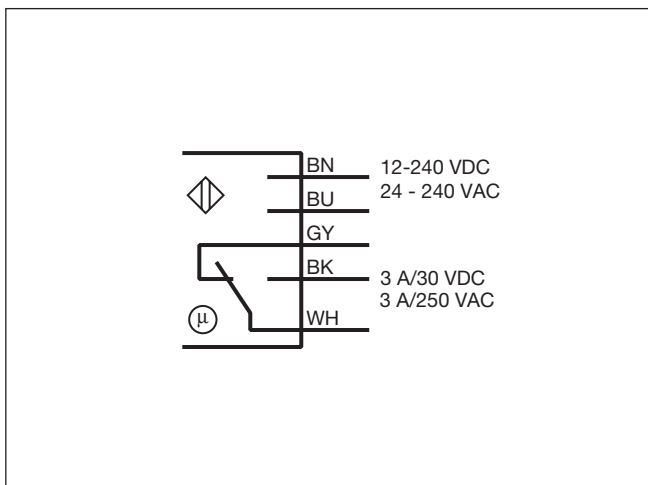

Detection Diagram

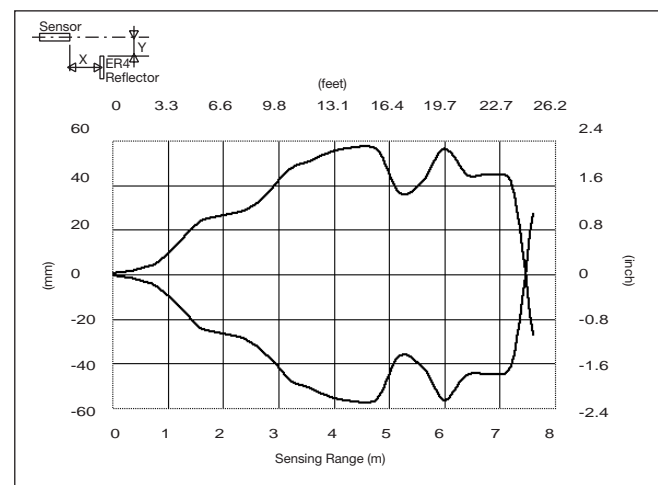

Signal Stability

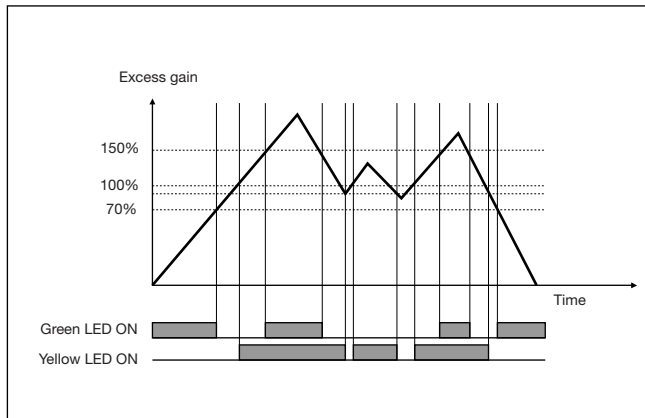

Excess Gain

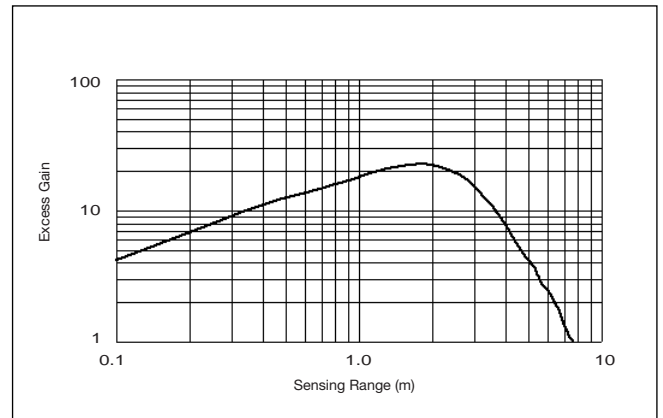

Delivery Contents

- Photoelectric switch: PC50CNP..
- Installation instruction
- Mounting bracket APC50-1
- **Packaging:** Cardboard box

Accessories

- Reflectors: ER-series
- Screwdriver for adjustment: 77-001

For further information refer to "Accessories"